

Bumpers & Wheel Chocks

LAMINATED AND MOLDED MAXIMUM PROTECTION FOR LOADING DOCKS, TRUCKS & CARGO

Laminated Bumpers

- Absorb 80% or more of impact force.
- Pressure laminated between heavy structural steel angles.
- Sizes and thicknesses to fit all needs.
- Attache easily to any surface.
- Models to meet government and postal requirements.
- Constructed of tread portion of belted ply tires only.
- Full length 3/4" steel rods welded to end angels - bolted end available.



Molded Bumpers

- Standard models in rectangular, "T" and "L Shapes.
- Nylon and rayon cord fibers throughout, minimizing chipping and tearing.
- Absorb shock of truck impact and spring to original shape.
- Some models available in 2", 3", and 4" thicknesses.
- Furnished with pre-drilled countersunk holes for easy installation and bolt head protection.

Laminated Wheel Chock

- Fabric-reinforced molded rubber; resist weather and offer long service life.
 - Recommended for compliance with OSHA requirements.
 - Other applications include the chocking of aircraft, rolls, barrels, and trailers.
 - Can be chained to dock for extra safety and efficiency.
 - Model WC-8 measures 8"x10"x6" and weighs approximately 10 lbs.
- Molded wheel chocks also available.

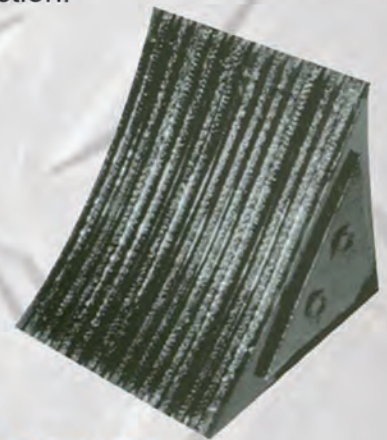

Quality Dock Levelers

Long Lasting

Easy to Install

Safe



Rugged. Dependable. PIONEER.

Bumpers & Wheel Chocks

PIONEER offers a complete line of finely crafted, technologically advanced loading dock equipment, including **Mechanical and Hydraulic Pit Levelers**, **Edge-of-Dock and Hydraulic Top of Dock Levelers**, **Portable Dock boards**, **Vehicle Restraints**, **Dock Seals & Shelters**, **High Speed Fabric Roll-Up Doors**, and other quality accessories. Just call us toll free for personal, professional customer assistance and responses to all of your product needs.

Molded Dock Bumpers

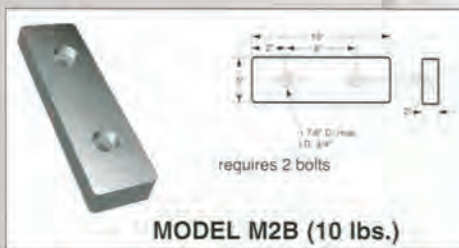
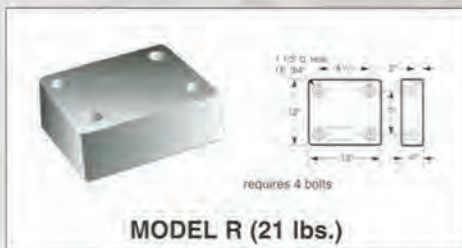
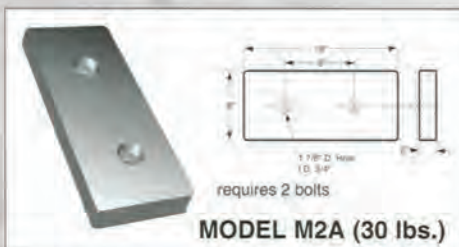
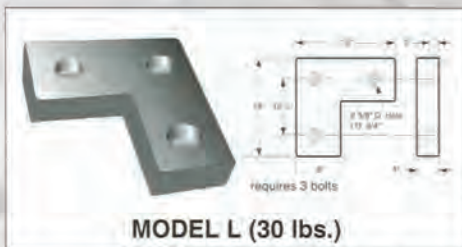
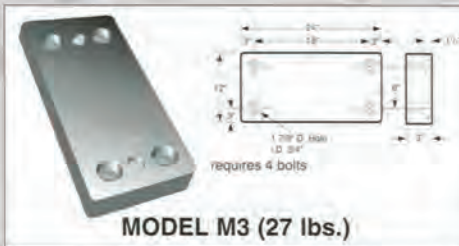
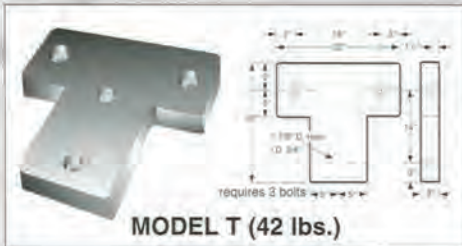

Specifications

Furnish and install molded, fiber reinforced rubber bumpers as furnished by PIONEER. Bumpers shall be reinforced with nylon and polyester fibers and shall meet or exceed ASTM 1170-95% AVE recovery rate standards.

Installation

Molded bumpers are furnished with pre-set countersunk anchor holes 3/4" in diameter. Anchors may be preset in new concrete or drilled into existing docks. Use 6" bolts for pre-set anchors and 5" bolts for drilled anchors. All bolts, hex nuts, and washers should be cadmium or galvanized plated.

MODEL D Extruded Rubber Bumpers

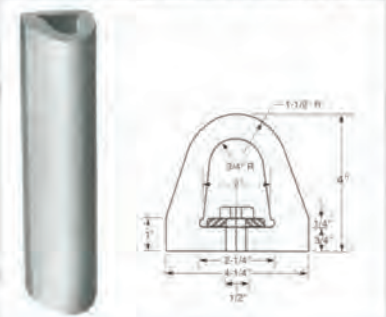

Extruded bumpers are appropriate for outdoor or indoor applications where impact protection is required. Lengths to 6'. Steel mounting bolts and washer furnished if desired. Holes are pre-drilled and units are ready to install.



Rugged. Dependable. PIONEER.

Dealer Locations

Call Dick Jones Sales 800-441-9955